

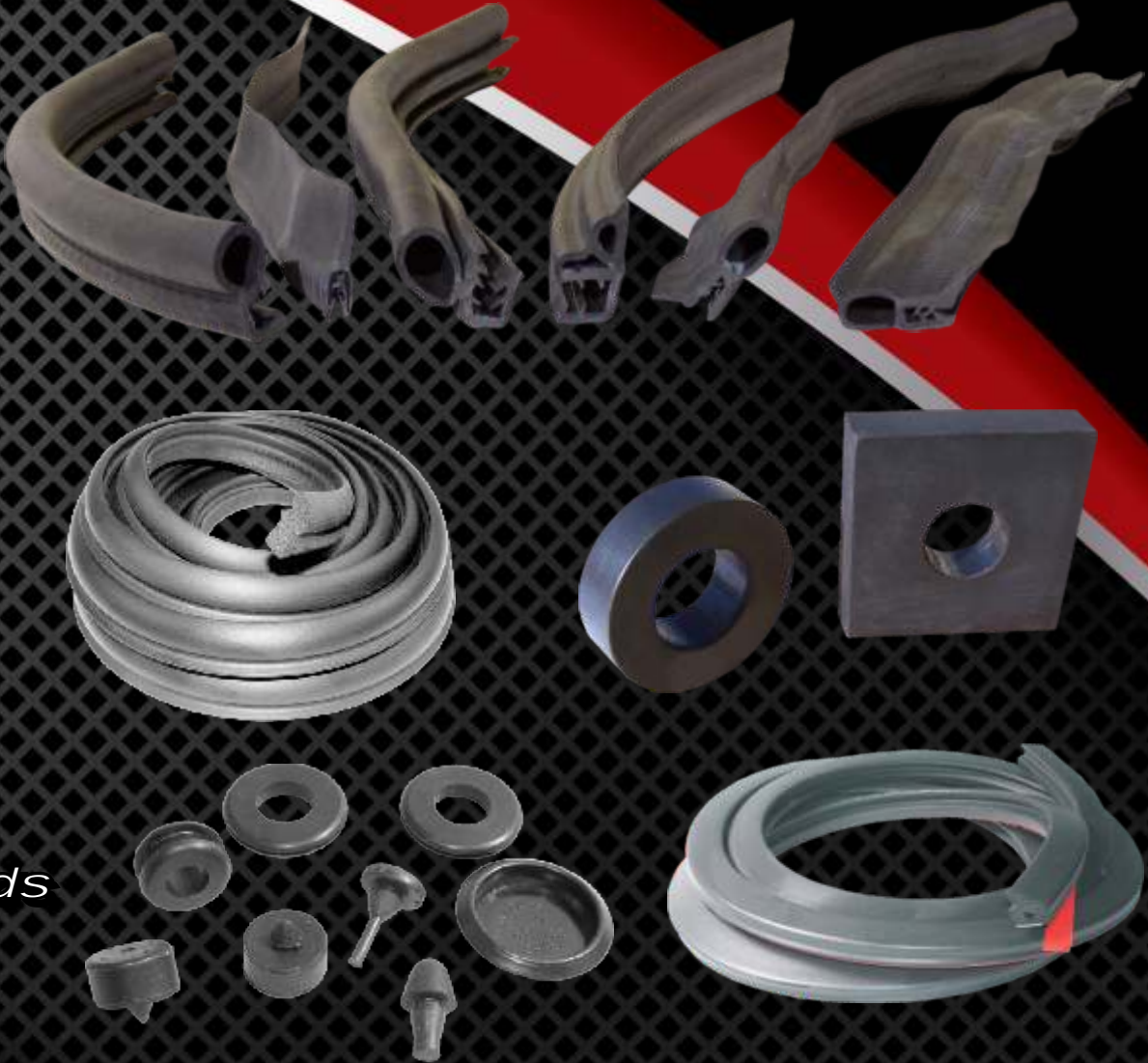

# Universal Parts Catalog

Quality Crafted Rubber Seals and Parts

- *Universal Seals*
- *Rubber Edging*
- *Trim Seals*
- *Locking Gaskets*
- *Grommets*
- *Bumpers & Plugs*
- *Rubber Bushings*
- *Rubber Mounting Pads*
- *Peel-N-Stick Parts*



## UNIVERSAL SEALS

DENSE RUBBER SEALS ..... 2

SPONGE RUBBER SEALS ..... 10

## SPECIALTY SEALS

PEEL-N-STICK SEALS ..... 16

RUBBER EDGING ..... 18

CLINCH SEALS ..... 19

RUN CHANNELS ..... 20

## GENERAL USE PARTS

GROMMETS ..... 22

BUMPERS ..... 23

PLUGS ..... 24

RUBBER SHEETING ..... 25

FENDER WELTING ..... 25

RUBBER BUSHINGS ..... 26

RUBBER PADS ..... 26

## ACCESSORIES

ADHESIVES ..... 27

TOOLS ..... 28

### Customer Service

Steele provides quality service both before and after your purchase. To place orders, check order status, request a catalog, or ask questions, simply call toll free 800-230-5871 or visit [www.steelerubber.com](http://www.steelerubber.com). For returns and additional assistance, please contact our Product Specialists at 704-483-9343.

### Our Guarantee

Quality is extremely important to us. We value our relationship with our customers and want your experience with Steele to be the best possible. We offer a 100% Money Back Guarantee on all parts manufactured by and purchased from Steele Rubber Products.



## DENSE RUBBER SEALS







SPONGE RUBBER SEALS ON PAGE 10



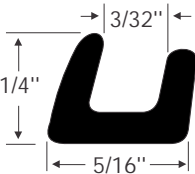
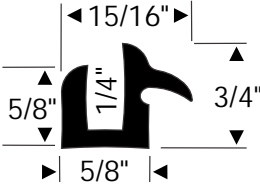
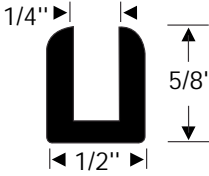
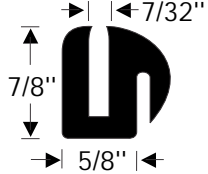

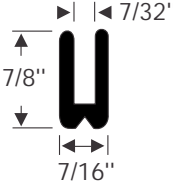
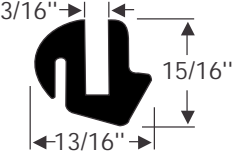
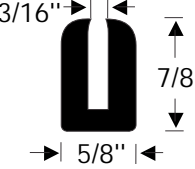
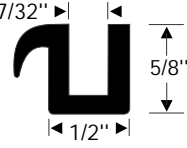
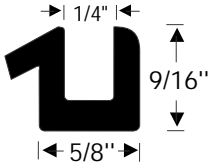
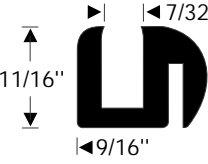

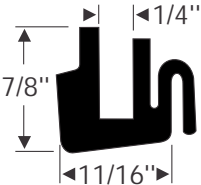
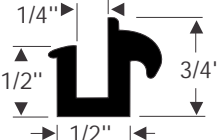
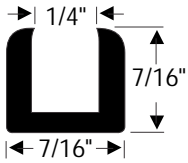
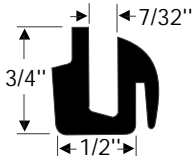
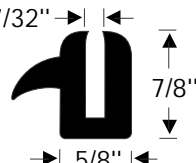
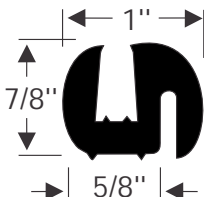
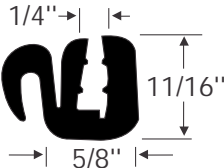
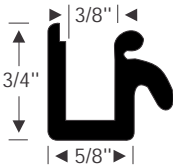
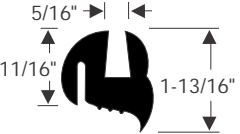
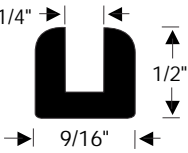
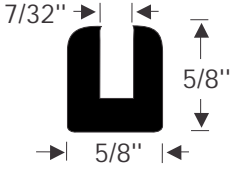
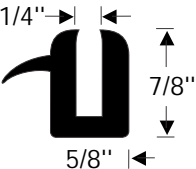

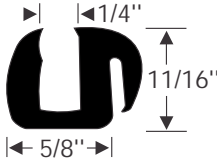
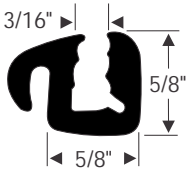
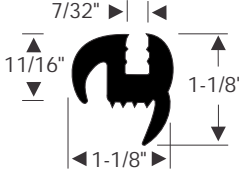
### How To Order

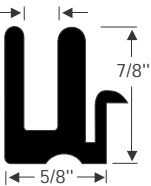
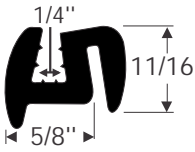
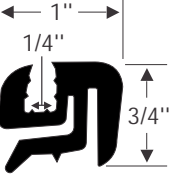
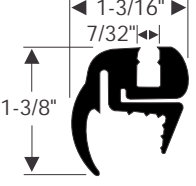
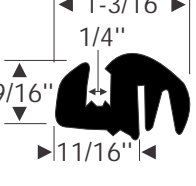
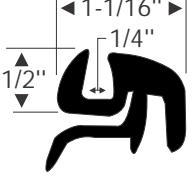
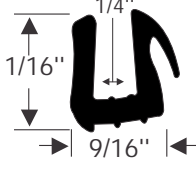
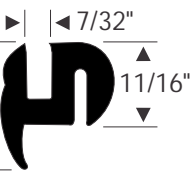
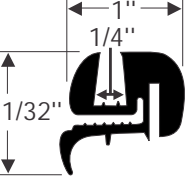
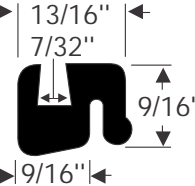
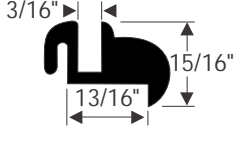
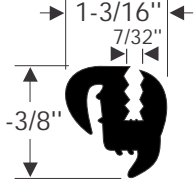
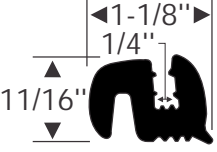
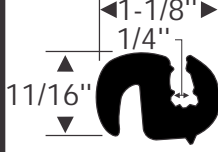
All of our universal seals, on pages 2-9, are sold "by the foot". Simply let us know how many feet you require, and we will cut to your custom length.

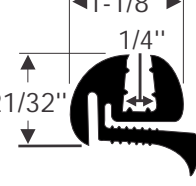
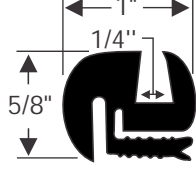

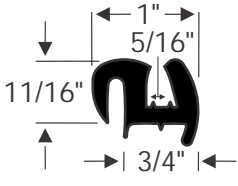
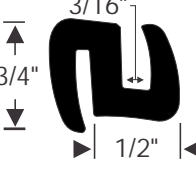

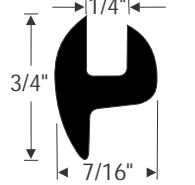
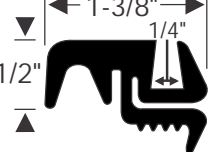
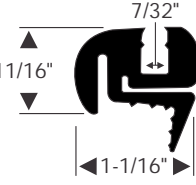
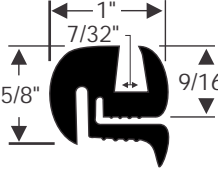
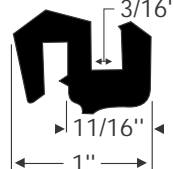
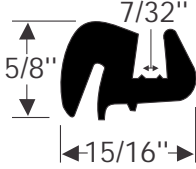

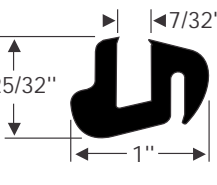
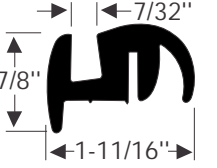
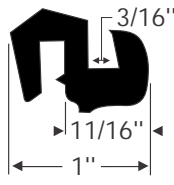
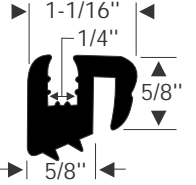
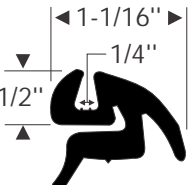
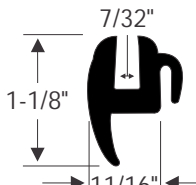

**Possible Uses:**  
Many of the seals on these pages are perfect for holding glass in a metal track, providing safety and great finishing looks.

 <p>27-0090-14</p>	 <p>70-1297-99</p>	 <p>30-0478-99</p>	 <p>70-1190-52</p>	 <p>50-0333-99</p>	 <p>30-0020-99</p>	 <p>30-0003-99</p>
 <p>70-1192-52</p>	 <p>30-0086-99</p>	 <p>70-1195-52</p>	 <p>40-0359-99</p>	 <p>60-0083-99</p>	 <p>40-0054-99</p>	 <p>70-1189-52</p>
 <p>30-0044-77</p>	 <p>40-0053-99</p>	 <p>70-1188-52</p>	 <p>50-0215-99</p>	 <p>40-0477-99</p>	 <p>40-0015-52</p>	 <p>60-0133-99</p>
 <p>70-0084-99</p>	 <p>70-1194-52</p>	 <p>70-1191-52</p>	 <p>70-2092-99</p>	 <p>30-0512-99</p>	 <p>70-1796-99</p>	 <p>60-0658-99</p>

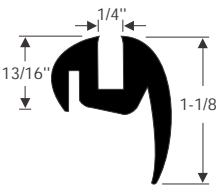
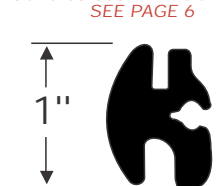
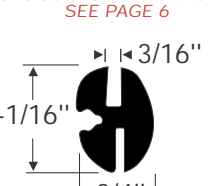
 <p>5/32"   7/8"   5/8"</p> <p>30-0014-99</p>	 <p>1/4"   11/16"   5/8"</p> <p>60-0549-99</p>	 <p>1"   1/4"   3/4"</p> <p>60-0552-99</p>	 <p>1-3/16"   7/32"   1-3/8"</p> <p>60-0130-99</p>	 <p>1-3/16"   1/4"   9/16"   11/16"</p> <p>60-0687-99</p>	 <p>1-1/16"   1/4"   1/2"</p> <p>60-0717-99</p>	 <p>1/4"   11/16"   9/16"</p> <p>70-3245-99</p>
 <p>7/32"   11/16"   7/8"</p> <p>12-0009-99</p>	 <p>1"   1/4"   1-11/32"</p> <p>50-0393-99</p>	 <p>13/16"   7/32"   9/16"   9/16"</p> <p>60-0576-99</p>	 <p>3/16"   15/16"   13/16"</p> <p>18-0004-77</p>	 <p>1-3/16"   7/32"   1-3/8"</p> <p>60-0728-99</p>	 <p>1-1/8"   1/4"   11/16"</p> <p>70-1028-99</p>	 <p>1-1/8"   1/4"   11/16"</p> <p>70-1029-99</p>
 <p>3/16"   13/16"   9/16"</p> <p>40-0360-99</p>	 <p>7/32"   1-3/16"   1-1/8"</p> <p>60-0273-99</p>	 <p>1-1/8"   1/4"   21/32"</p> <p>50-0482-99</p>	 <p>1"   1/4"   5/8"</p> <p>70-2241-99</p>	 <p>1 1/4"   7/16"   7/8"</p> <p>19-0006-99</p>	 <p>1"   5/16"   11/16"   3/4"</p> <p>70-1260-99</p>	 <p>3/16"   3/4"   1/2"</p> <p>70-3170-99</p>
 <p>1/4"   1-1/32"   11/16"</p> <p>50-0392-99</p>	 <p>1/4"   3/4"   7/16"</p> <p>19-0005-99</p>	 <p>1-3/8"   1/4"   1/2"</p> <p>60-0121-99</p>	 <p>7/32"   11/16"   1-1/16"</p> <p>60-0657-99</p>	 <p>1"   7/32"   5/8"   9/16"</p> <p>70-2253-99</p>	 <p>3/16"   11/16"   1"</p> <p>40-0437-99</p>	 <p>7/32"   5/8"   15/16"</p> <p>70-0998-99</p>
 <p>7/32"   13/16"   1/2"   15/16"</p> <p>60-0038-99</p>	 <p>7/32"   25/32"   1"</p> <p>40-0415-99</p>	 <p>7/32"   7/8"   1-11/16"</p> <p>60-0551-99</p>	 <p>3/16"   11/16"   1"</p> <p>40-0436-99</p>	 <p>1-1/16"   1/4"   5/8"   5/8"</p> <p>70-3176-99</p>	 <p>1-1/16"   1/4"   1/2"</p> <p>60-0718-99</p>	 <p>7/32"   1-1/8"   11/16"</p> <p>18-0003-83</p>

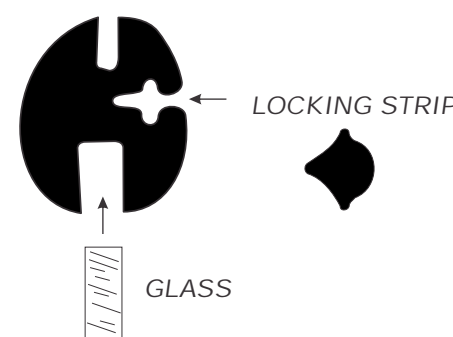

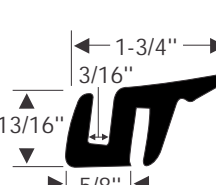
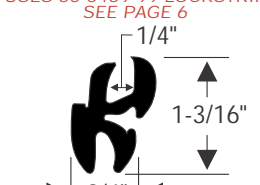
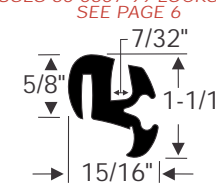
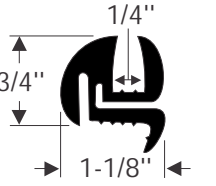
# Universal Seals

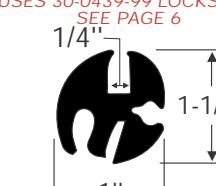
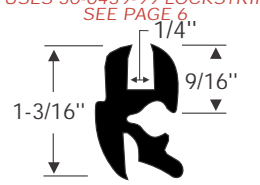
 <p>40-0096-99</p>	 <p>60-0661-99</p>	<p>USES 60-0607-99 LOCKSTRIP SEE PAGE 6</p>  <p>40-0507-99</p>	<p>USES 60-0607-99 LOCKSTRIP SEE PAGE 6</p>  <p>70-0587-99</p>	<p>USES 30-0439-99 LOCKSTRIP SEE PAGE 6</p>  <p>40-0432-99</p>	<p>USES 60-0607-99 LOCKSTRIP SEE PAGE 6</p>  <p>40-0548-99</p>	<p>USES 30-0439-99 LOCKSTRIP SEE PAGE 6</p>  <p>40-0496-99</p>
 <p>70-3286-99</p>	<p>USES 30-0439-99 LOCKSTRIP SEE PAGE 6</p>  <p>30-0436-99</p>	<p>USES 30-0439-99 LOCKSTRIP SEE PAGE 6</p>  <p>40-0433-99</p>	<p>USES 30-0439-99 LOCKSTRIP SEE PAGE 6</p>  <p>40-0520-99</p>	<div data-bbox="1272 478 2091 1554"> <h2>LOCKING STRIPS</h2>  <p>UNIVERSAL SEAL THAT ACCEPTS LOCKING STRIP (many on this page use a lock strip)</p>  <p>LOCKING STRIP</p> <p>GLASS</p> <div data-bbox="1412 1234 1908 1428">  <p><b>LOCKING STRIPS</b></p> <p>LOCKING STRIPS can be used with many of the dense rubber seals on this page. Please see Page 5 for a list of locking strips.</p> </div> <p>Ask us about locking strip tools.</p> </div>		
 <p>70-3169-99</p>	<p>USES 30-0439-99 LOCKSTRIP SEE PAGE 6</p>  <p>70-1644-99</p>	<p>SELF LOCKING</p>  <p>40-0484-99</p>	<p>USES 60-0607-99 LOCKSTRIP SEE PAGE 6</p>  <p>70-1261-99</p>			
 <p>70-1428-99</p>	<p>USES 30-0439-99 LOCKSTRIP SEE PAGE 6</p>  <p>40-0435-99</p>	<p>SELF LOCKING</p>  <p>40-0516-99</p>	<p>USES 30-0439-99 LOCKSTRIP SEE PAGE 6</p>  <p>40-0511-99</p>			
 <p>60-0523-99</p>	<p>USES 30-0439-99 LOCKSTRIP SEE PAGE 6</p>  <p>30-0498-99</p>	<p>USES 60-0607-99 LOCKSTRIP SEE PAGE 6</p>  <p>60-0082-99</p>	<p>USES 30-0439-99 LOCKSTRIP SEE PAGE 6</p>  <p>40-0519-99</p>			

## LOCKING STRIPS



### LOCKING STRIPS

LOCKING STRIPS can be used with many of the dense rubber seals on page 4.

UNIVERSAL SEAL THAT ACCEPTS LOCKING STRIP (Page 6)

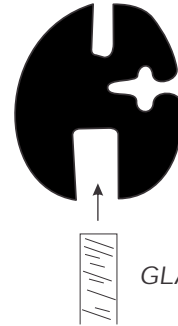

← LOCKING STRIP

GLASS

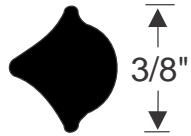

60-0607-99  
Sold per/foot

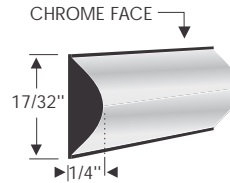

70-1919-52  
15ft. Strip

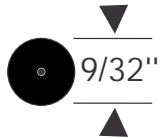

30-0439-99  
Sold per/foot

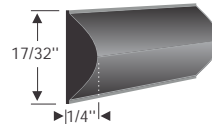

70-1918-52  
15ft. Strip

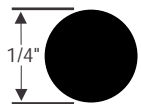

70-2195-52  
16ft. Strip

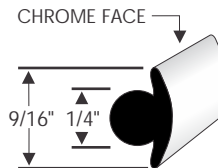

70-2196-52  
16ft. Strip

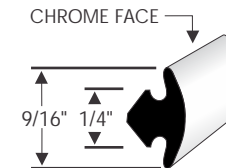

70-3425-52  
11ft. Strip



## Quality Crafted Rubber Parts

- Expert Service
- Huge Inventory
- Same Day Shipping
- Manufacturer Direct

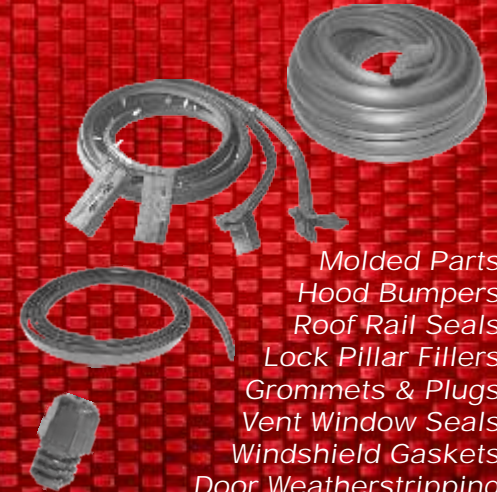

Molded Parts  
Hood Bumpers  
Roof Rail Seals  
Lock Pillar Fillers  
Grommets & Plugs  
Vent Window Seals  
Windshield Gaskets  
Door Weatherstripping  
Trunk Weatherstripping  
And Much More!

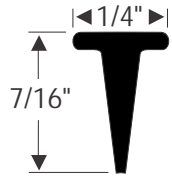

19-0023-73

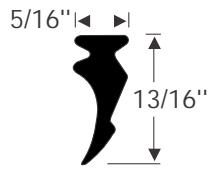

40-0018-99

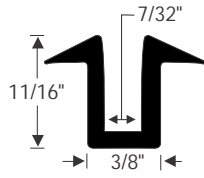

70-0241-57

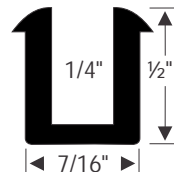

30-0154-57

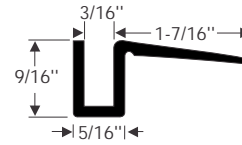

70-0489-58

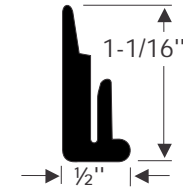

30-0035-65



70-0081-67

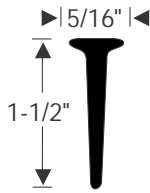

19-0024-52

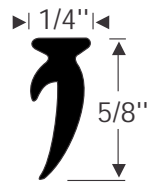

40-0033-99

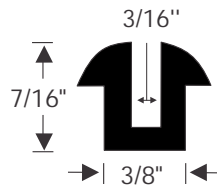

70-2324-57

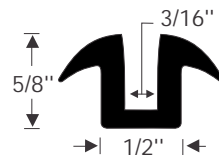

70-1193-99

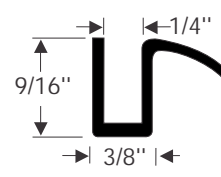

60-0059-83

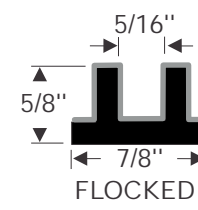

70-1168-58

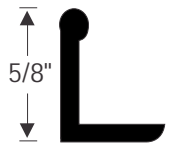

11-0010-57

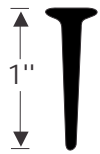

70-1163-52

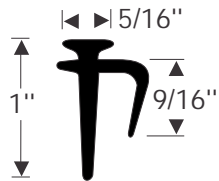

70-0015-99

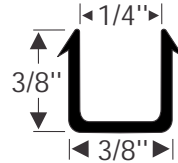

70-2642-57

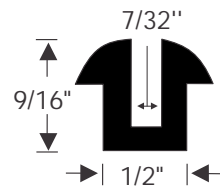

70-0018-99

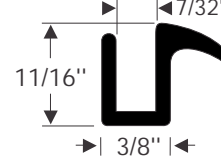

70-0075-57



70-0306-58

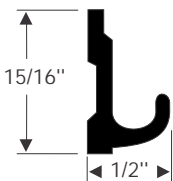

40-0095-99

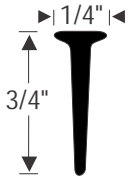

70-0142-52

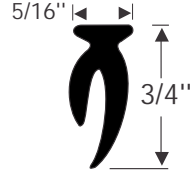

40-0036-99

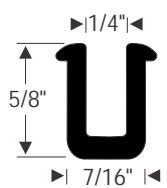

30-0507-57

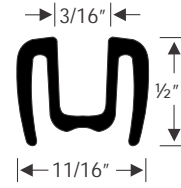

70-2844-57

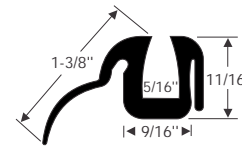

70-2093-99

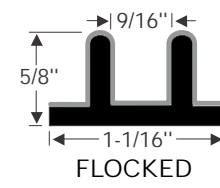

70-1169-58

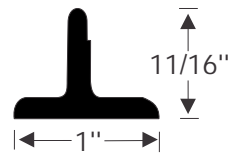

70-0060-65

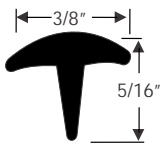

70-2841-99

All of our dense universal rubber seals, on pages 2-9, are sold "by the foot". Simply let us know how many feet you require, and we will cut to your custom length.

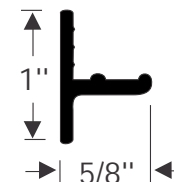

50-0528-62

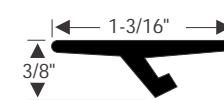

19-0004-52

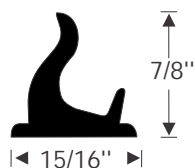

70-0251-65

The "Setting Channel" extrusions listed below are designed to fold in a "U" shape to hold glass away from a metal frame.

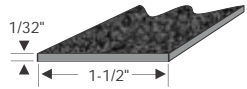
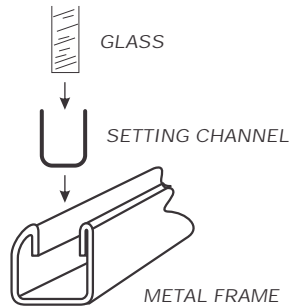

SETTING CHANNEL - CORK

70-1114-57  
Sold per/foot

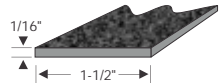

SETTING CHANNEL - CORK

70-1115-57  
Sold per/foot



SETTING CHANNEL - CLOTH

70-2863-58  
Sold per/foot



SETTING CHANNEL - RUBBER

70-2169-57  
Sold per/foot







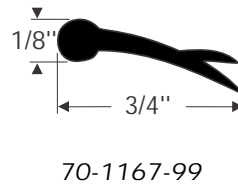
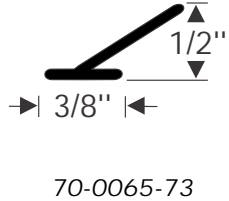
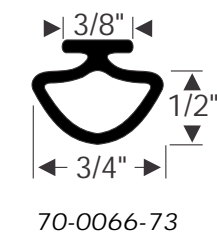
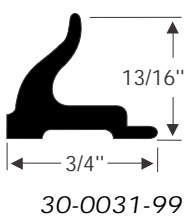
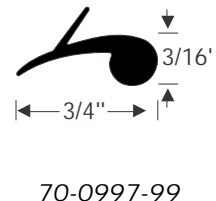
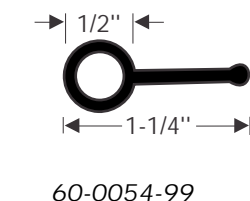
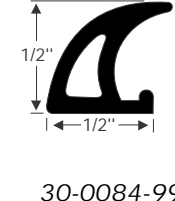
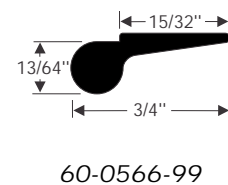
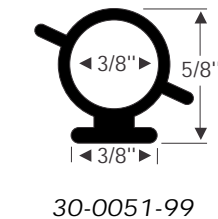
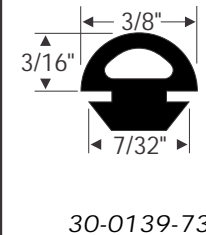
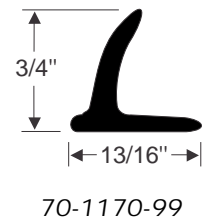
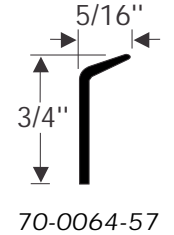
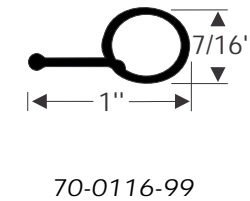
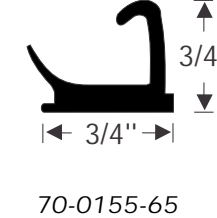
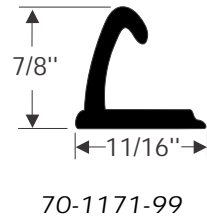
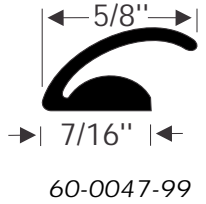
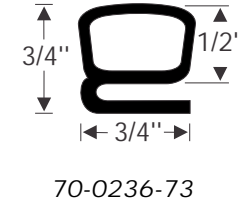
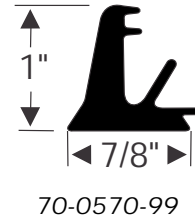



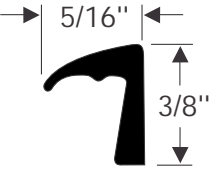
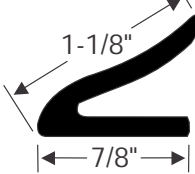
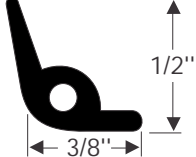
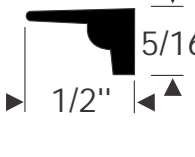
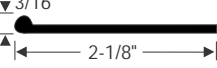
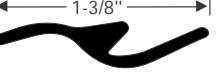
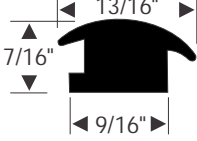

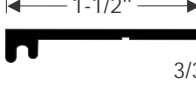

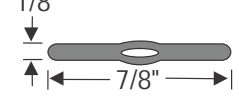
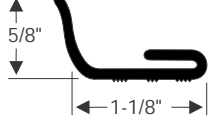
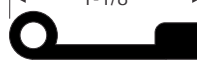

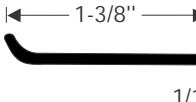
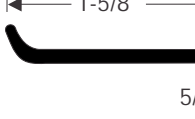
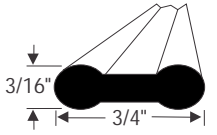
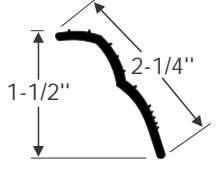

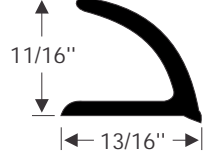

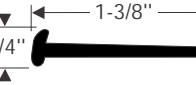
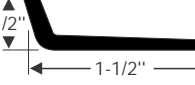
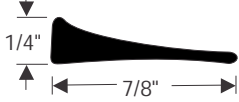
SETTING CHANNEL - RUBBER

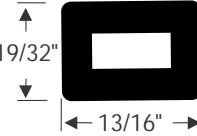
70-2170-57  
Sold per/foot

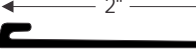

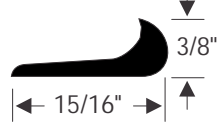
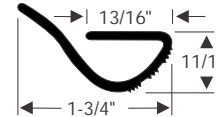

 <p>70-0079-58</p>	 <p>70-1446-99</p>	 <p>70-0231-85</p>	 <p>70-0585-58</p>	 <p>70-0019-52</p>	 <p>40-0487-73</p>	 <p>20-0102-45</p>
 <p>60-0078-99</p>	 <p>70-2424-99</p>	 <p>60-0055-52</p>	 <p>70-2166-99</p>	 <p>LACING - FABRIC</p> <p>60-0578-42</p>	 <p>70-1448-73</p>	 <p>70-1656-99</p>
 <p>70-0140-99</p>	 <p>70-2423-99</p>	 <p>70-1236-48</p>	 <p>70-1237-48</p>	 <p>70-2221-42</p>	 <p>60-0660-45</p>	 <p>60-0653-99</p>
 <p>40-0475-42</p>	 <p>70-2422-99</p>	 <p>70-0308-17</p>	 <p>60-0667-45</p>	 <p>60-0287-99</p>	 <p>27-0106-30</p>	 <p>70-2396-99</p>
 <p>60-0153-99</p>	 <p>50-0541-37</p>	 <p>70-1693-57</p>	 <p>30-0482-41</p>	 <p>12-0010-99</p>	 <p>70-1292-73</p>	 <p>70-1583-99</p>

Many of our "U-Shaped" Seals can be used for covering rough or dangerous edges. These work great on Metal, Plastic or Fiberglass.

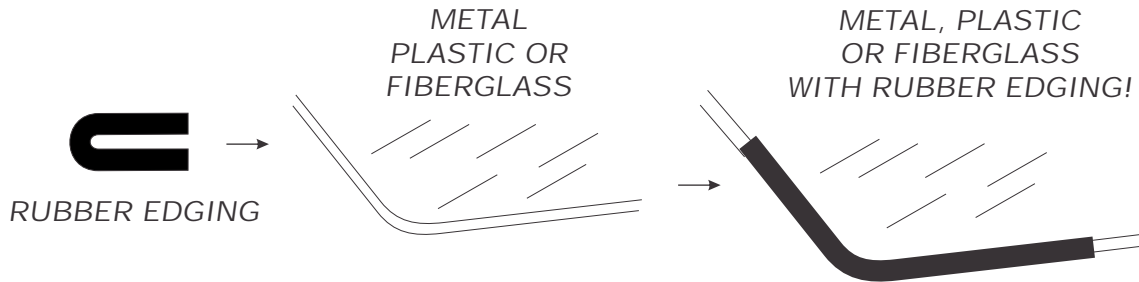

<p>70-0077-99</p>	<p>70-3166-99</p>	<p>70-3246-99</p>	<p>70-0836-99</p>
<p>60-0685-99</p>	<p>50-0100-99</p>	<p>70-2856-99</p>	

All of our dense universal rubber seals, on pages 2-9, are sold "by the foot". Simply let us know how many feet you require, and we will cut to your custom length.



## Quality Crafted Rubber Parts

- Expert Service
- Huge Inventory
- Same Day Shipping
- Manufacturer Direct



Molded Parts  
Hood Bumpers  
Roof Rail Seals  
Lock Pillar Fillers  
Grommets & Plugs  
Vent Window Seals  
Windshield Gaskets  
Door Weatherstripping  
Trunk Weatherstripping

And Much More!

## SPONGE RUBBER SEALS

DENSE RUBBER SEALS ON PAGE 2

### How To Order

All of our universal seals, on pages 2-13, are sold "by the foot". Simply let us know how many feet you require, and we will cut to your custom length.



**Possible Uses:**  
Many of the seals on these pages are perfect for sealing doors and windows.

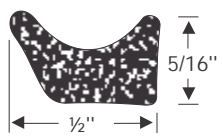

70-1789-99

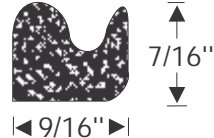

70-0390-73



70-0331-73



70-1244-73

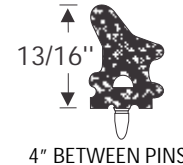

70-1245-73

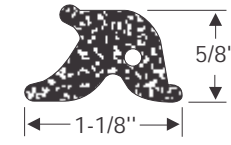

60-0456-99

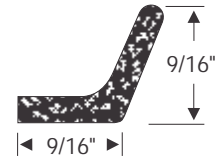

70-1269-99

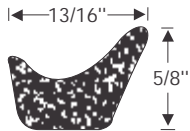

50-0085-73



60-0416-99

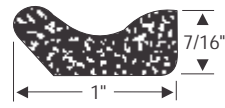

30-0470-99



70-1111-73

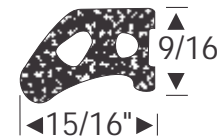

70-1731-99

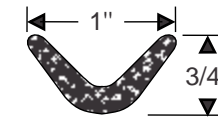

70-3371-99

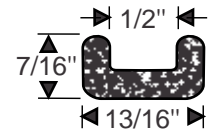

70-2705-99

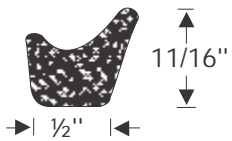

70-0145-73

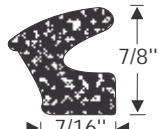

70-0492-73

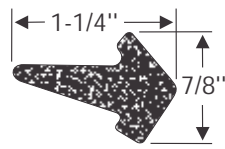

70-1267-99

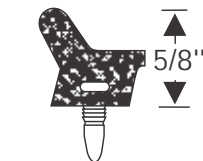

70-1112-73

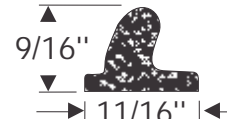

70-0653-99

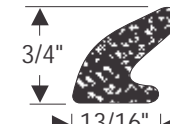

20-2618-99

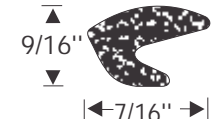

60-0411-85

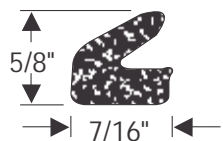

40-0480-73

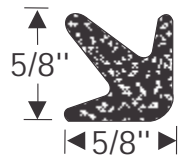

70-0219-73



70-0311-73

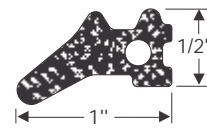

70-1045-99

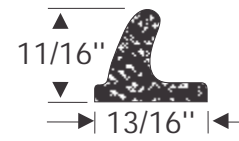

70-0491-73

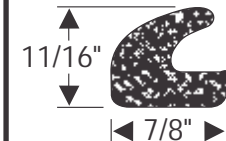

20-0042-99



20-1389-99

 <p>60-0562-99</p>	 <p>70-1258-99</p>	 <p>70-2124-99</p>	 <p>70-3228-99</p>	 <p>20-0302-99</p>	 <p>70-1037-99</p>	 <p>70-1036-99</p>
 <p>40-0168-73</p>	 <p>70-1776-99</p>	 <p>40-0490-99</p>	 <p>70-2992-99</p>	 <p>70-2329-99</p>	 <p>70-0598-99</p>	 <p>70-1673-99</p>
 <p>50-0219-99</p>	 <p>40-0513-85</p>	 <p>60-0731-99</p>	 <p>70-2727-99</p>	 <p>70-3155-99</p>	 <p>70-0654-99</p>	 <p>40-0442-99</p>
 <p>70-0411-73</p>	 <p>70-2989-99</p>	 <p>70-1085-99</p>	 <p>70-1662-99</p>	 <p>70-3154-99</p>	 <p>50-0340-99</p>	 <p>70-1665-99</p>
 <p>60-0114-99</p>	 <p>60-0732-99</p>	 <p>70-1750-99</p>	 <p>70-1663-99</p>	 <p>70-1035-99</p>	 <p>70-0906-99</p>	 <p>70-1677-99</p>





70-1667-99



70-1669-99



70-1266-99

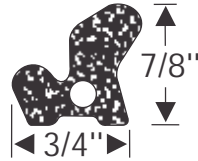

70-0586-99

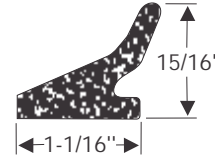

60-0651-99

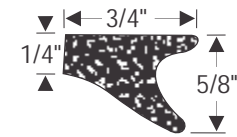

70-1437-99

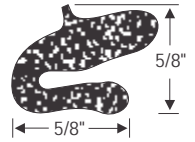

70-3113-99

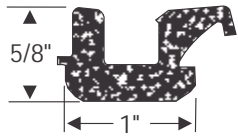

70-1674-99

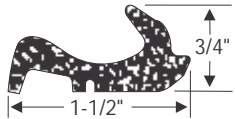

70-1666-99



70-0839-99

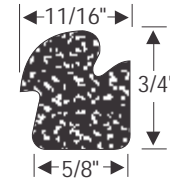

30-0356-85

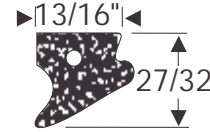

70-0509-99



82-0030-99

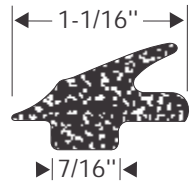

40-0479-85



70-1678-99

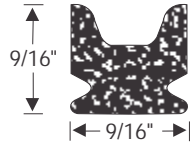

40-0280-57



60-0695-99

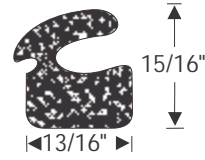

70-0412-85

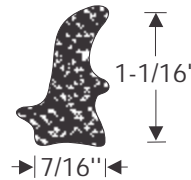

70-0346-85

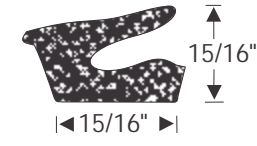

70-0490-85

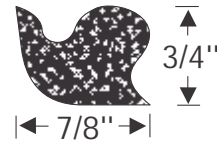

70-0463-85

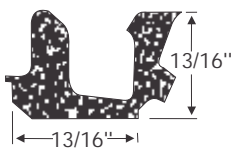

40-0441-99

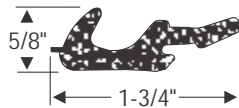

70-1672-99

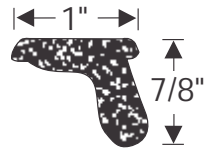

70-2394-99

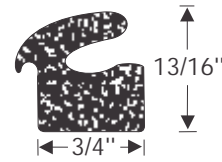

50-0161-85

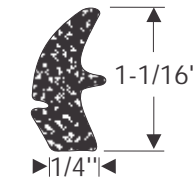

70-0650-85



40-0443-99



70-1670-99

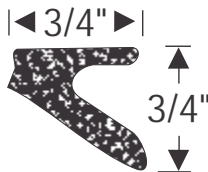

70-2401-99



70-2393-99

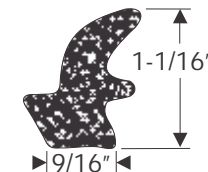

70-0510-85

**Steele**  
RUBBER PRODUCTS

Visit [www.steelerubber.com](http://www.steelerubber.com)  
for over 12,000 rubber parts  
and weatherstripping

DOOR SEALS TRUNK SEALS

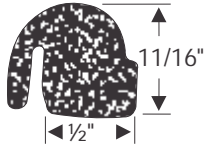

20-1688-99

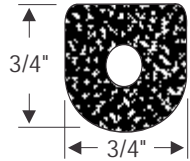

70-0518-85

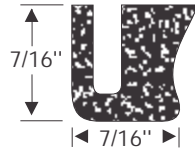

40-0162-99

All of our sponge universal rubber seals, on pages 10-13, are sold "by the foot". Simply let us know how many feet you require, and we will cut to your custom length.

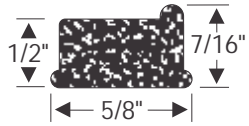

30-0144-87

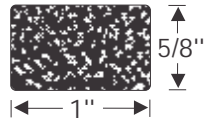

70-0129-99

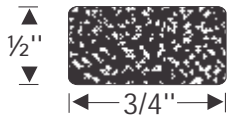

70-1105-99

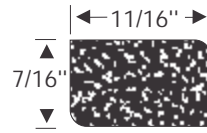

30-0243-73



70-1106-99

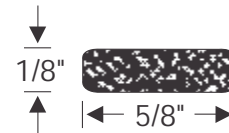

70-0519-85



30-0308-99



70-0777-99



70-0701-99

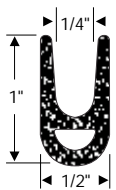

70-2118-99

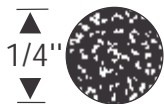

70-0957-99

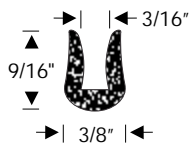

70-2119-99

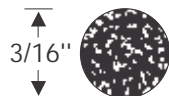

70-0884-99

**WE ALSO OFFER**  
*Quality Crafted*  
**Rubber Parts & Weatherstripping**

*SINCE 1958*

BUICK - OLDSMOBILE - PONTIAC - CHEVROLET - CADILLAC  
GMC TRUCK - FORD - LINCOLN - MERCURY - CHRYSLER  
PLYMOUTH - DODGE - DESOTO - AMERICAN INDEPENDENTS

**\*ASK ABOUT A CUSTOM CATALOG  
SPECIFIC FOR YOUR CAR OR TRUCK\***

**Steele**  
RUBBER PRODUCTS

YouTube f Twitter



WE ALSO OFFER CLASSIC CAR & TRUCK WEATHERSTRIPPING



**SINCE 1958**

# CUSTOM CATALOGS NOW AVAILABLE!



Get your completely customized Steele Rubber Products Catalog! You tell us what you're working on and we'll send you a catalog full of parts specifically for that car or truck. Order as many catalogs as you have projects!



[steelerubber.com/parts](http://steelerubber.com/parts)



**SINCE 1958**

# Our Universal Parts are for Anything!

We built our reputation over decades of producing the highest quality rubber parts and weatherstrip seals for the classic and antique vehicles. Now, we bring our experience and commitment to quality to our line of universal rubber seals. From cars and trucks to boats and recreational vehicles, you can be confident in the great looks, high performance and long life of our universal rubber seals.



## Don't See The Part You Need?

We have thousands of rubber profiles and extrusions in our inventory that may not be listed in this catalog. Give us a call and one of our Product Specialists can assist you in finding the right part for your next project.

**call or email: [parts@steelerubber.com](mailto:parts@steelerubber.com)**



## PEEL-N-STICK SEALS



Our Peel-N-Stick weatherstripping can be used any place a rubber seal is needed. With easy to use Peel-N-Stick adhesive backing, simply cut to size and fit to the areas you need to seal. Available in multiple lengths and a variety of extrusions, our Peel-N-Stick parts are made of the same quality sponge & dense rubber found in our standard rubber parts and weatherstripping.



"No messy glue, Just peel and stick!"

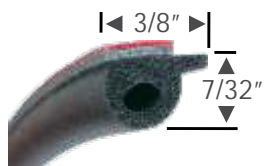

SPONGE RUBBER  
83-0102-73 • 5ft.  
83-0103-73 • 10ft.  
83-0124-73 • 15ft.  
83-1016-73 • 30ft.

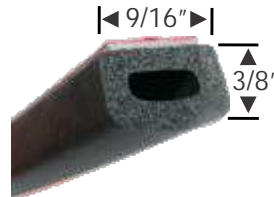

SPONGE RUBBER  
83-0109-73 • 5ft.  
83-0110-73 • 10ft.  
83-0111-73 • 15ft.  
83-1020-73 • 30ft.



SPONGE RUBBER  
83-0125-73 • 5ft.  
83-0126-73 • 10ft.  
83-0122-73 • 15ft.  
83-1021-73 • 30ft.

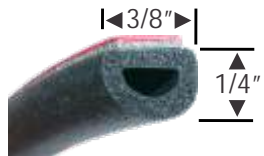

SPONGE RUBBER  
83-0104-73 • 5ft.  
83-0105-73 • 10ft.  
83-0106-73 • 15ft.  
83-1017-73 • 30ft.



SPONGE RUBBER  
83-0107-73 • 5ft.  
83-0108-73 • 10ft.  
83-0130-73 • 15ft.  
83-1019-73 • 30ft.



SPONGE RUBBER  
83-0128-73 • 5ft.  
83-0129-73 • 10ft.  
83-0119-73 • 15ft.  
83-1022-73 • 30ft.

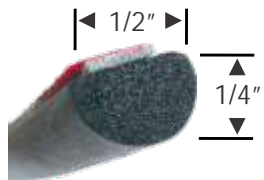

SPONGE RUBBER  
83-0127-73 • 5ft.  
83-0113-73 • 10ft.  
83-0114-73 • 15ft.  
83-1018-73 • 30ft.

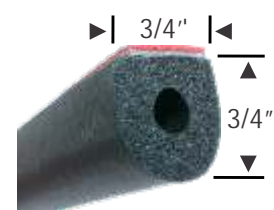

SPONGE RUBBER  
83-1023-85 • 5ft.  
83-1024-85 • 10ft.  
83-1025-85 • 15ft.  
83-1026-85 • 30ft.



SPONGE RUBBER  
83-0131-73 • 5ft.  
83-0132-73 • 10ft.  
83-0100-73 • 15ft.  
83-0118-73 • 30ft.

## PEEL-N-STICK SEALS

Exclusively Made With  
**3M**<sup>™</sup>  
QUALITY ADHESIVE TAPE  
HOLDS TIGHTER • LASTS LONGER



83-0135-73  
10ft.  
SPONGE RUBBER



83-0137-73  
10ft.  
SPONGE RUBBER



83-0134-73  
10ft.  
SPONGE RUBBER



83-0136-73  
10ft.  
SPONGE RUBBER



83-0140-73  
10ft.  
SPONGE RUBBER



83-0123-73  
10ft.  
SPONGE RUBBER



83-0139-73  
10ft.  
SPONGE RUBBER



83-0133-73  
10ft.  
SPONGE RUBBER



83-0138-73  
10ft.  
SPONGE RUBBER



**Possible Uses:**

These parts are often used as roof rail seals for cars & trucks.



**Possible Uses:**

These parts are some of our most universal Peel-N-Stick extrusions. Great for many applications!

ALL EXTRUSIONS ARE SPONGE RUBBER

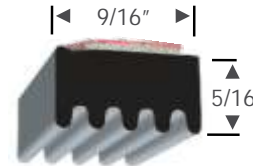

83-1040-73 • 5ft.  
83-1041-73 • 10ft.  
83-1042-73 • 30ft.

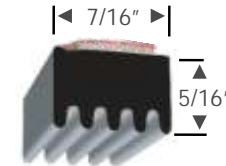

83-1037-73 • 5ft.  
83-1038-73 • 10ft.  
83-1039-73 • 30ft.

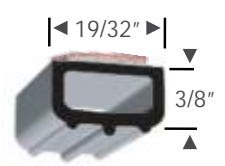

83-1046-73 • 5ft.  
83-1047-73 • 10ft.  
83-1048-73 • 30ft.

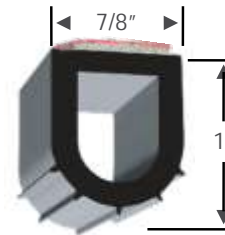

83-1049-73 • 5ft.  
83-1050-73 • 10ft.  
83-1051-73 • 30ft.



83-1035-73 • 10ft.  
83-1036-73 • 30ft.

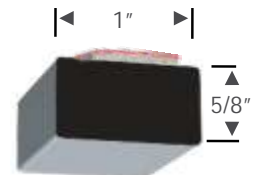

83-1031-73 • 10ft.  
83-1032-73 • 30ft.

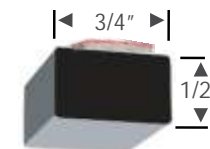

83-1033-73 • 10ft.  
83-1034-73 • 30ft.



83-1029-73 • 10ft.  
83-1030-73 • 30ft.

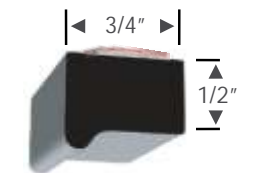

83-1027-73 • 10ft.  
83-1028-73 • 30ft.

## PEEL-N-STICK SEALS



**Possible Uses:**  
Perfect for window scraper seal applications on many types of vehicles.

FUZZY FLOCKED SURFACE PROTECTS WINDOW GLASS

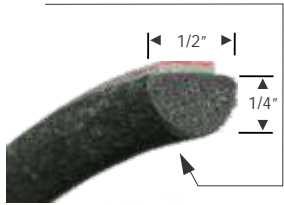

**SPONGE RUBBER**  
70-2813-60 • 5ft.  
70-2814-60 • 10ft.  
70-2815-60 • 15ft.



**DENSE RUBBER**  
70-2816-60 • 5ft.  
70-2817-60 • 10ft.  
70-2818-60 • 15ft.



**DENSE RUBBER**  
70-2820-60 • 5ft.  
70-2821-60 • 10ft.  
70-2822-60 • 15ft.

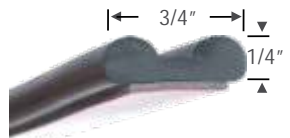

**DENSE RUBBER**  
70-2674-42 • 9ft.  
70-2675-42 • 14ft.



**SPONGE RUBBER**  
70-2684-42 • 9ft.  
70-2685-42 • 14ft.



**Possible Uses:**  
Can be used for a clean looking hood-to-cowl seal that is easy to install.

## RUBBER EDGING

### U-SHAPE SEALS



These "U-Shape" Seals can be used for covering rough or dangerous edges. These work great on Metal, Plastic or Fiberglass.



CLINCH Type edging seals are listed on page 21



**SPONGE RUBBER**  
83-0115-73 • 10ft.  
83-0116-73 • 15ft.  
Also available by the foot. See page 13.



**DENSE RUBBER**  
70-3167-33 • 10ft.  
70-3168-33 • 15ft.  
Also available by the foot. See page 9.

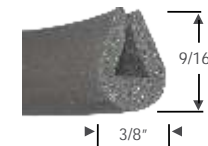

**SPONGE RUBBER**  
83-0120-73 • 10ft.  
83-0121-73 • 15ft.  
Also available by the foot. See page 13.



**DENSE RUBBER**  
70-3247-44 • 10ft.  
70-3248-44 • 15ft.  
Also available by the foot. See page 9.

### GLASS SEALS



**DENSE RUBBER**  
70-2860-52 • 15ft.



**Possible Uses:**  
Use T-shaped seals as trim for sealing a variety of glass types.

### ALSO AVAILABLE

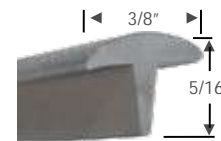

**DENSE RUBBER**  
70-2851-52 • 12ft.  
70-2850-52 • 20ft.  
Also available by the foot. See page 6.

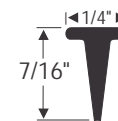

19-0023-73  
**DENSE RUBBER**

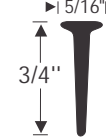

70-0142-52  
**DENSE RUBBER**

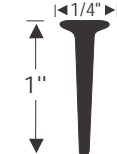

70-1163-52  
**DENSE RUBBER**

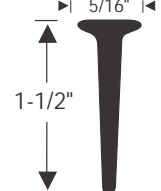

19-0024-52  
**DENSE RUBBER**

These extrusions are also listed on page 6 and are sold per foot

## CLINCH SEALS

### SIDE CHANNEL BULB

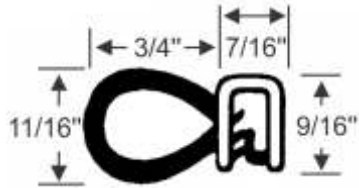

70-3582-99 • per/ft.



70-3594-99  
25ft. Strip

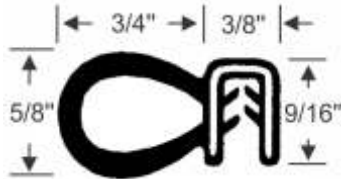

70-3583-99 • per/ft.



70-3592-99 • per/ft.

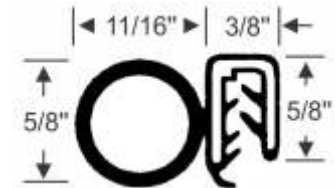

70-3584-99 • per/ft.

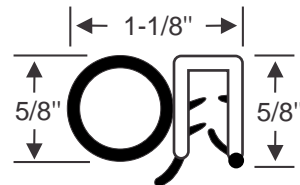

70-3456-99  
25ft. Strip

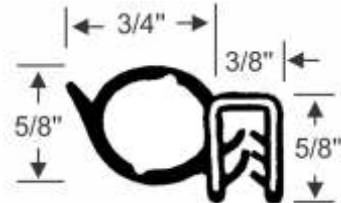

70-3586-99  
25ft. Strip

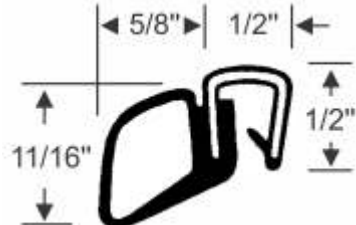

70-3595-99  
25ft. Strip

### BOTTOM CHANNEL BULB

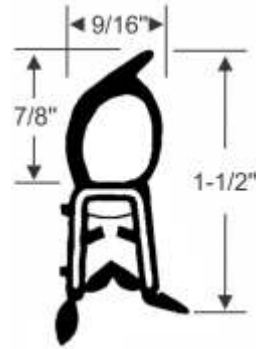

70-3585-99  
25ft. Strip

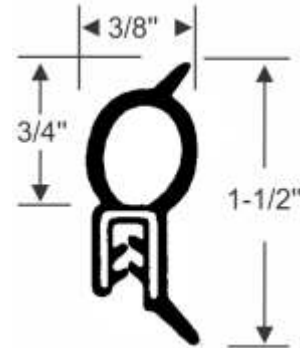

70-3589-99 • per/ft.



70-3587-99  
25ft. Strip

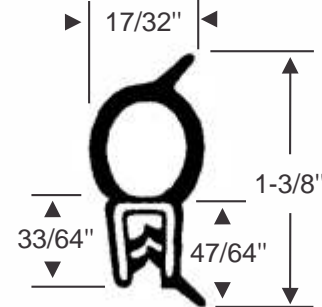

70-3590-99 • per/ft.

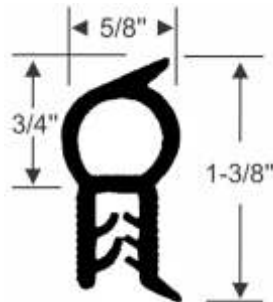

70-3588-99  
25ft. Strip

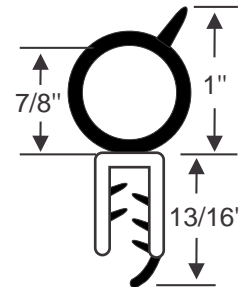

70-2831-99  
25ft. Strip

### NON BULB

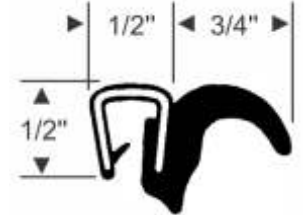

70-3593-99  
25ft. Strip

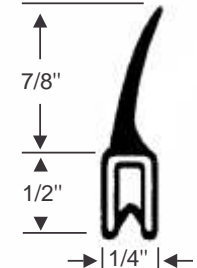

70-3591-99 • per/ft.

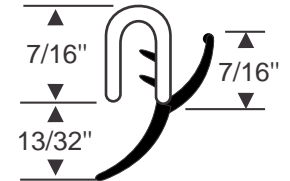

70-2746-99 • per/ft.

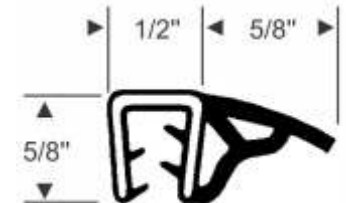

70-3581-99 • per/ft.



The tube shaped bulbs are made of high quality sponge rubber. The flexible metal cores can bend to grip edges tightly, providing a simple and safe way to seal.

MORE  
CLINCH SEALS  
ON PAGE 20.



## EDGING CLINCH SEALS

These Clinch Seals can be used for covering rough or dangerous edges. These work great on Metal, Plastic or Fiberglass.

## CLINCH SEALS

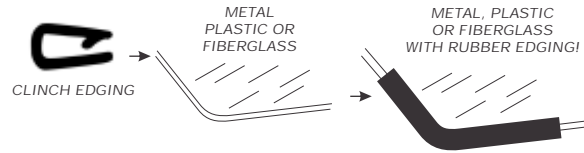

FOR 1/8" TO 3/16" EDGES

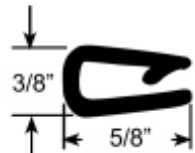

70-3600-99 • per/ft.

FOR 3/16" TO 1/4" EDGES



70-3598-99 • per/ft.

FOR 1/8" EDGES



70-3601-99 • per/ft.

FOR 1/32" EDGES



70-3597-99 • per/ft.

FOR 1/32" TO 1/8" EDGES

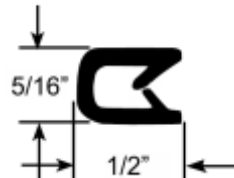

70-3602-99 • per/ft.

FOR 1/8" TO 3/16" EDGES



70-3599-99 • per/ft.

FOR 1/32" EDGES

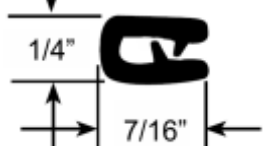

70-3596-99 • per/ft.

 The flexible metal cores can bend to grip edges tightly, providing a simple and safe way to seal.

Rubber edging seals are listed on page 18

## RUN CHANNELS

## FLOCKED RUN CHANNEL

Run Channels with a flocked lining create a smooth surface for gliding window panels. Works great with glass, acrylic, fiberglass or plastic. These fibers provide low friction, flexibility and long life.

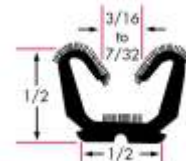

70-3570-58 • 96" Strip

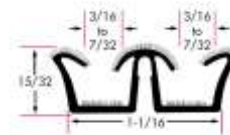

70-3571-58 • 96" Strip

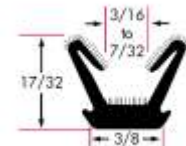

70-3572-58 • 96" Strip



70-3573-58 • 60" Strip



70-3574-58 • 96" Strip

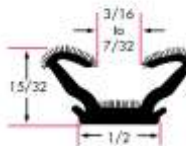

70-3575-58 • 96" Strip



70-3576-58 • 72" Strip

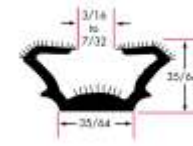

70-3577-58 • 96" Strip



70-3578-58 • 96" Strip

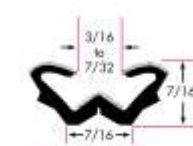

70-3579-58 • 96" Strip



70-3580-58 • 96" Strip



**SINCE 1958**

# Our Universal Parts are for Anything!

We built our reputation over decades of producing the highest quality rubber parts and weatherstrip seals for the classic and antique vehicles. Now, we bring our experience and commitment to quality to our line of universal rubber seals. From cars and trucks to boats and recreational vehicles, you can be confident in the great looks, high performance and long life of our universal rubber seals.



## Don't See The Part You Need?

We have thousands of rubber profiles and extrusions in our inventory that may not be listed in this catalog. Give us a call and one of our Product Specialists can assist you in finding the right part for your next project.

**call or email: [parts@steelerubber.com](mailto:parts@steelerubber.com)**

# General Use Parts

## ROUND GROMMETS

This is a sample design  
Actual grommets  
may be different.

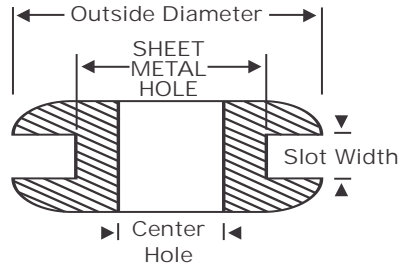

Our round grommets can be used for a variety of sheet metal applications. Grommets are listed below by the size of the sheet metal hole. Call for assistance.

*NOTE: The sheet metal hole size of the grommet will be slightly smaller than the actual hole for better sealing.*

Part Number	SHEET METAL HOLE	Center Hole	Outside Diameter	Slot Width
32-1059-20	1/4"	5/32"	3/8"	1/16"
32-1060-20	1/4"	5/32"	7/16"	3/32"
32-1062-20	9/32"	3/16"	7/16"	1/8"
32-1063-20	5/16"	3/16"	7/16"	1/4"
32-1061-20	5/16"	3/16"	1/2"	1/16"
32-0352-20	3/8"	1/4"	1/2"	3/32"
32-0414-32	3/8"	3/16"	9/16"	3/16"
32-1064-20	3/8"	1/4"	1/2"	1/16"
32-1058-20	3/8"	1/8"	1/2"	1/16"
32-0317-52	7/16"	1/4"	3/4"	1/16"
32-0366-53	7/16"	1/8"	5/8"	1/16"
32-1065-20	7/16"	1/4"	5/8"	1/16"
32-0537-24	7/16"	1/4"	3/4"	1/16"
32-1067-20	7/16"	5/16"	9/16"	1/16"
32-0365-20	1/2"	3/16"	3/4"	1/16"
32-0514-20	1/2"	1/4"	5/8"	3/32"
32-0161-21	1/2"	3/8"	11/16"	1/16"
32-1073-20	9/16"	7/16"	3/4"	1/16"
32-1070-20	9/16"	5/16"	13/16"	1/4"
32-0132-67	9/16"	3/8"	13/16"	1/8"
32-0051-24	9/16"	3/8"	5/8"	1/8"
32-0491-21	9/16"	3/8"	5/8"	1/8"
32-1069-20	9/16"	5/16"	13/16"	1/8"
32-1068-20	9/16"	5/16"	13/16"	1/16"
32-1071-20	5/8"	3/8"	7/8"	1/16"
32-0158-17	5/8"	5/16"	13/16"	1/16"
32-1072-20	5/8"	3/8"	7/8"	1/4"
32-0970-17	5/8"	1/4"	7/8"	1/8"
32-0112-20	5/8"	1/4"	1-3/16"	1/16"

Part Number	SHEET METAL HOLE	Center Hole	Outside Diameter	Slot Width
32-0047-14	11/16"	3/8"	1"	1/16"
32-0165-15	11/16"	1/8"	1"	1/16"
32-0050-24	11/16"	1/2"	3/4"	1/4"
32-0003-21	11/16"	1/4"	1"	1/16"
32-0328-54	11/16"	5/16"	7/8"	1/16"
32-0342-24	3/4"	3/8"	1"	1/4"
32-1075-20	3/4"	1/2"	1"	1/16"
32-0438-20	3/4"	1/2"	1"	1/8"
32-0064-21	3/4"	1/4"	1"	1/16"
32-1074-20	3/4"	1/2"	31/32"	1/8"
32-0263-17	3/4"	5/16"	13/16"	1/16"
32-0066-20	3/4"	1/4"	15/16"	1/16"
32-0162-21	3/4"	7/16"	15/16"	1/16"
32-0002-21	13/16"	3/8"	1-1/8"	1/16"
32-1076-20	13/16"	1/2"	1-1/16"	1/4"
32-0224-21	7/8"	5/8"	1-1/8"	1/16"
32-1077-20	7/8"	5/8"	1-1/8"	1/8"
32-0057-24	7/8"	1/4"	1-1/4"	1/8"
32-0364-37	7/8"	5/8"	1-1/4"	1/8"
32-0155-37	7/8"	1/2"	1-3/8"	1/16"
32-1078-20	15/16"	3/4"	1-1/8"	3/32"
32-0464-15	1"	3/8"	1-1/8"	1/16"
32-1066-20	1"	1/4"	1-1/4"	1/16"
32-0437-20	1"	1/2"	1-3/8"	3/32"
32-0714-41	1"	3/8"	1-3/8"	1/16"
32-0492-14	1"	11/16"	1-1/4"	1/16"
32-0253-37	1"	5/8"	2-1/8"	1/8"
32-0320-21	1"	5/8"	1-3/8"	1/16"

Part Number	SHEET METAL HOLE	Center Hole	Outside Diameter	Slot Width
32-0439-20	1"	1/2"	1-1/4"	3/32"
32-0039-14	1"	9/16"	1-1/4"	1/16"
32-0390-21	1"	3/4"	1-5/16"	3/32"
32-0133-21	1"	3/4"	1-1/4"	3/16"
32-0098-21	1"	7/16"	1-3/8"	3/32"
32-0401-45	1"	3/8"	1-1/4"	1/16"
32-0369-20	1-1/16"	3/4"	1-3/8"	3/32"
32-1201-20	1-1/16"	9/16"	1-5/8"	3/32"
32-0134-20	1-1/8"	7/8"	1-3/8"	5/32"
32-0005-14	1-1/8"	5/8"	1-1/2"	1/6"
32-0167-52	1-1/8"	7/8"	1-1/2"	1/16"
32-0001-37	1-1/8"	3/4"	1-1/2"	1/8"
32-0365-37	1-1/8"	5/8"	1-1/2"	1/16"
32-0355-37	1-3/16"	5/8"	2"	1/16"
32-0062-14	1-3/16"	3/4"	1-1/2"	1/8"
32-0421-37	1-3/16"	13/16"	1-5/8"	1/4"
32-0422-20	1-3/16"	1/2"	1-7/16"	1/4"
32-0220-21	1-1/4"	1/4"	1-1/2"	3/32"
32-0063-14	1-1/4"	1/2"	1-5/8"	1/16"
32-0455-14	1-1/4"	7/8"	1-5/8"	1/16"
32-1079-20	1-1/4"	3/4"	1-5/8"	1/4"
32-0118-37	1-1/4"	3/4"	1-5/8"	1/16"
32-0160-20	1-3/8"	7/16"	1-5/8"	3/16"
32-0062-20	1-3/8"	5/16"	1-7/8"	1/8"
32-0023-14	1-3/8"	1"	2"	1/16"
32-0333-20	1-3/8"	7/16"	1-3/4"	1/8"
32-0196-21	1-3/8"	3/8"	1-1/2"	1/16"
32-0225-20	1-1/2"	11/16"	2-1/4"	3/32"

## STEM BUMPERS

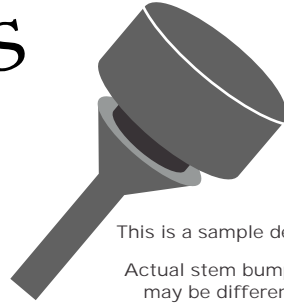

This is a sample design  
Actual stem bumpers  
may be different.

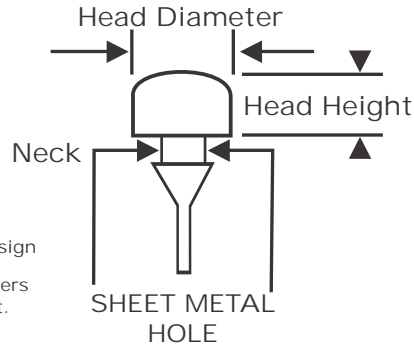

Our stem bumpers can be used to protect a variety of sheet metal applications. Grommets are listed below by the size of the sheet metal hole. Call for assistance.

NOTE: The sheet metal hole size of the neck will be slightly smaller than the actual hole for better sealing.

Part Number	SHEET METAL HOLE	Head Diameter	Head Height
33-0730-42	1/8"	13/32"	1/8"
33-0127-41	1/8"	5/16"	5/32"
33-0128-88	1/8"	5/16"	1/4"
33-0556-15	1/8"	1/2"	1/16"
33-0348-54	3/16"	1/2"	5/8"
33-0368-30	3/16"	13/32"	7/16"
33-0507-62	3/16"	7/16"	5/32"
33-0123-42	1/4"	3/4"	1/2"
33-0512-44	1/4"	3/8"	3/16"
33-0136-42	1/4"	7/16"	3/16"
33-0211-31	1/4"	9/16"	1/4"
33-0293-87	1/4"	15/16"	5/16"
33-0459-42	1/4"	3/4"	3/16"
33-0496-71	1/4"	1/2"	3/8"
33-0990-87	1/4"	15/16"	7/16"
33-1285-42	1/4"	9/16"	5/32"
33-0117-42	1/4"	5/8"	5/16"
33-0395-42	1/4"	5/8"	3/32"
33-0046-42	1/4"	3/4"	5/16"
33-0349-87	1/4"	1/2"	3/32"



Part Number	SHEET METAL HOLE	Head Diameter	Head Height
33-0350-87	1/4"	15/16"	3/8"
33-0427-42	1/4"	5/8"	3/16"
33-0482-42	1/4"	5/8"	7/16"
33-0016-45	3/8"	1"	11/32"
33-0169-42	3/8"	3/4"	3/8"
33-1574-71	1/4"	5/8"	1/4"
33-0003-42	1/4"	3/4"	1/8"
33-0042-42	1/4"	13/32"	1/2"
33-0019-20	1/4"	7/16"	3/16"
33-0449-42	1/4"	9/32"	15/32"
60-0734-71	9/32"	9/16"	1/4"
33-1576-71	5/16"	19/32"	17/32"
33-1575-71	5/16"	5/8"	3/4"
33-0531-42	5/16"	13/16"	1/4"
33-0031-42	5/16"	1/2"	3/16"
33-0109-71	5/16"	3/4"	9/32"
33-0116-42	5/16"	3/4"	1/2"
33-0542-42	5/16"	3/4"	5/16"
33-0113-42	5/16"	3/4"	3/16"
33-0293-71	3/8"	3/4"	3/4"

Stem bumpers come in a variety of shapes. These are examples of different stem bumpers.



Part# 33-0127-41



Part# 33-0348-54



Part# 33-0211-31



## BODY PLUGS



This is a sample design

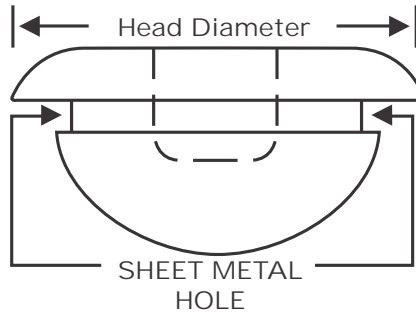

Our body plugs can be used for a variety of sheet metal applications. Body Plugs are listed by the size of the sheet metal hole. Call for assistance.

*NOTE: The sheet metal hole size of the plug will be slightly smaller than the actual hole for better sealing.*

Body plugs come in a variety of sizes. These are examples of our body plugs



Part# 32-0456-20



Part# 35-0369-20



Part# 35-1214-20

Part Number	SHEET METAL HOLE	Head Diameter	Material
35-0458-45	3/8"	7/16"	Rubber
32-0456-20	7/16"	3/4"	Rubber
35-0369-20	1/2"	13/16"	Rubber
35-0070-87	1/2"	3/4"	Rubber
35-1052-20	1/2"	7/8"	Plastic
35-0171-20	9/16"	13/16"	Rubber
35-0197-31	3/4"	1-3/8"	Rubber
35-0262-20	3/4"	7/8"	Rubber
35-0515-20	3/4"	1"	Rubber
35-1053-20	3/4"	1-1/8"	Plastic
35-0402-87	7/8"	1-1/8"	Rubber
35-1054-20	7/8"	1-1/4"	Plastic
35-1214-20	15/16"	1-5/16"	Rubber
35-0099-20	1"	1-1/4"	Rubber
35-0457-45	1"	1-3/8"	Rubber
35-1055-20	1"	1-3/8"	Plastic
35-0327-45	1-1/4"	1-9/16"	Rubber
35-1056-20	1-1/4"	1-5/8"	Plastic
35-0517-45	1-3/8"	1-3/4"	Rubber
35-3508-45	2"	2-3/8"	Rubber



- Expert Service
- Huge Inventory
- Same Day Shipping
- Manufacturer Direct

Quality Crafted Rubber Parts

Since 1958





## UNIVERSAL PARTS

These pages contain parts that can be used for a variety of uses.

### Battery Terminal Cover

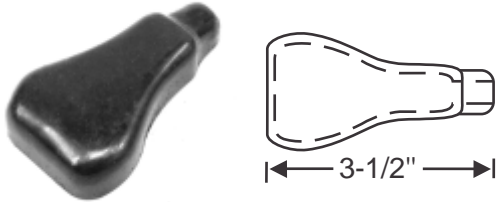

Cover, battery clamp. Control unsightly sulfate buildup. Can be used on most any vehicle battery.

70-0095-21

### Rubber Sheeting



Please order rubber sheeting by the square foot as shown here.

4 Ft. Wide Roll.	4'X1'	4'X2'	4'X3'	4'X4'	4'X5'
	4 SQF.	8 SQF.	12 SQF.	16 SQF.	20 SQF.
	-----	-----	-----	-----	-----
	-----	-----	-----	-----	-----
	-----	-----	-----	-----	-----

Rubber masticated sheet. 3/32" thick rubber sheet containing random milled cotton cord reinforcement. Perfect for front end automobile splash aprons. Many other uses as well. This product is four (4) foot high, and will only be sold in four (4) foot multiples (4' x 1', 4' x 2', 4' x 3', etc...). Please order by the square foot.

70-0645-45

### Fender Welting for Automobiles



BLACK



CHROME

Fender welting. Superior quality, proper construction of reinforced black vinyl over vinyl core. 1-3/8" inch wide. One fourth (1/4" Or 3/16" bead, 25' or 50' roll. Typically used to attach fenders to automobile body.

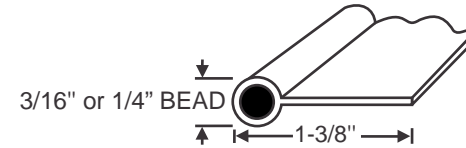

- 70-1097-44 - 1/4" bead, 25' roll.
- 70-1098-44 - 1/4" bead, 50' roll.
- 70-1099-44 - 3/16" bead, 25' roll.
- 70-1100-44 - 3/16" bead, 50' roll.
- 70-1101-44 - CHROME, 3/16" bead, 25' roll.
- 70-1102-44 - CHROME, 3/16" bead, 50' roll.

### Dimmer Switch Grommet

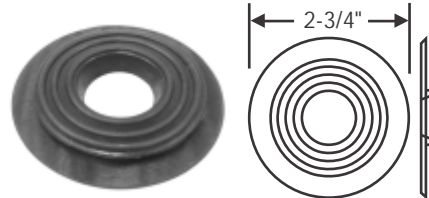

Dimmer switch grommet for automobiles. Has a wide flange for 1" hole for carpet application. 2-3/4" inches overall.

40-0083-88

### Push Button Lock Knobs



Knob or push button for inside door lock, fits over 1/8" steel rod to door lock. Hard brown rubber, may be lacquered other colors as required. OEM for many GM cars but can be used for other vehicles.

70-0660-70



Knob or push button for inside door lock, fits over 1/8" steel rod to door lock. Neutral brown rubber. OEM for many GM cars but can be used for other vehicles.

70-0354-70

## Round Rubber Bushings

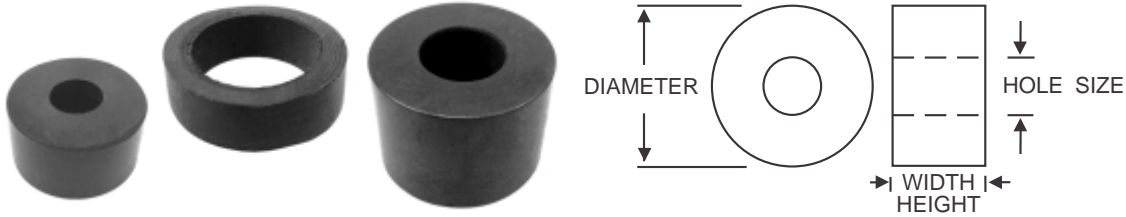

Listed by hole size

	DIAMETER	WIDTH HEIGHT	HOLE SIZE		DIAMETER	WIDTH HEIGHT	HOLE SIZE
50-0133-48	1-5/8"	15/16"	3/8"	70-0264-48	1-7/16"	1/4"	9/16"
50-0132-48	2"	5/16"	3/8"	11-0019-35	1-3/8"	1-1/8"	5/8"
60-0231-11	1-1/2"	13/16"	3/8"	60-0463-11	2-1/2"	1-1/4"	5/8"
60-0232-11	1-7/8"	13/16"	3/8"	10-0134-32	7/8"	1/4"	5/8"
60-0235-33	7/8"	5/8"	3/8"	50-0229-11	2-3/16"	1/2"	5/8"
70-1124-33* <small>CORK</small>	1-3/16"	1/4"	7/16"	70-2233-48	1-7/8"	1/2"	5/8"
70-1125-33	1-3/16"	1/4"	7/16"	11-0020-35	1-1/2"	1-1/8"	11/16"
60-0216-33	1-3/16"	3/4"	7/16"	50-0329-48	1-15/16"	3/4"	3/4"
70-1968-33	1-1/4"	5/8"	7/16"	50-0097-48	2"	1/2"	3/4"
11-0016-33	1-1/4"	11/16"	1/2"	50-0507-48	1-7/8"	3/4"	13/16"
70-0265-48	1-1/2"	1-1/4"	1/2"	60-0189-48	1-7/8"	9/16"	7/8"
70-1967-33	1-1/2"	7/8"	9/16"	70-2232-48	1-7/8"	1/2"	15/16"

## Square/Rectangle Rubber Pads



Listed by hole size

	LENGTH	WIDTH	HEIGHT	HOLE SIZE
50-0233-48	2-7/16"	1-11/16"	3/8"	1/2"
50-0231-48	3"	1-5/8"	1/4"	1/2"
50-0232-48	1-15/16"	1-15/16"	3/8"	1/2"
50-0328-48	2"	2"	7/16"	5/8"
70-2234-48	2-1/8"	2-1/8"	1/2"	3/4"
70-0634-48	3-1/8"	2"	3/8"	3/4"



### Possible Uses:

Our rubber bushings and rubber pads can be used anywhere a cushion barrier is needed. Our Square/Rectangle pads are perfect for use as body mounting pads when restoring automobiles.

# Adhesives



**Loctite Super Bonder 495**  
General purpose instant adhesive designed to bond rubber, metal, and plastic parts. Excellent for modified gaskets or rubber footage made of dense or sponge rubber.  
96-0495-96 (3 gm. Tube)



**3M Super Weatherstrip Adhesive (Yellow)**  
For adhering all types of rubber weatherstripping to car doors and trunks. An excellent adhesive for bonding engine gaskets. Can be used for adhering vinyl trim headliners and side panels. Light colored adhesive. Very fast drying, exceptional bonding strength.  
96-8001-96 (5 oz. Tube)



**3M Super Weatherstrip Adhesive (Black)**  
It is a strong, flexible, rubbery adhesive that with stands vibration and extreme temperature variations. Primarily designed for use on T-Tops, Moon-Roofs. Because of its black color, clean-up is eliminated due to its blending in with the rubber.  
96-8008-96 (5 oz. Tube)



**3M Weatherstrip Adhesive (Black)**  
For bonding trim fabrics (except vinyl), trunk linings, floor mats, and rugs, silencer pads, KB board; also good general purpose rubber cement. Has quick tack, will not bleed through fabric.  
96-8011-96 (5 oz. Tube)



**3M Plastic and Emblem Adhesive**  
An excellent clear adhesive for plastic repair and emblem application. Use this strong, quick-drying adhesive for plastic or metal emblems, interior rigid plastic, tail light lenses, vinyl side moldings or upholstery.  
96-8061-96 (5 oz. Tube)



**3M Clear Auto Sealer**  
A non-yellowing, optically clear sealer for sealing windshields, drip moldings, reveal moldings, truck ornaments, taillights, and other small seams on the auto body. Also useful for sealing convertible tops and matching convertible back lights.  
96-8551-96 (5 oz. Tube)



**3M General Trim Adhesive**  
A rapid drying, high strength, light colored adhesive in an aerosol container. Designed for bonding most types of material used in automotive trim operations except unsupported vinyl. Excellent for fabrics, upholstery, foam, jute pads, carpets, re-bonding vinyl top sections, etc. Has adjustable spray pattern, high initial strength and does not require shaking or agitation before using. Provides good heat resistance.  
**CANNOT BE SHIPPED VIA AIR**  
96-8080-96 (16.25 oz. Aerosol)

**3M Auto Bedding and Glazing Compound**  
A non-hardening water resistant, medium bodied sealer for sealing auto body, seams, under moldings and between windshield rubber and car body. Remains permanently soft and pliable without shrinking to absorb movement in the auto body. Neutral color is clean and easy to use and eliminates clean-up on windshield rubber, etc. Easy to Use-Stop-Flo Plunger on each cartridge prevents oozing. has dry rag cleanup.



96-8509-96 (10 oz. Cartridge)

**3M General Purpose Adhesive Cleaner - Spray**  
Quickly cleans off wax, grease, oil, old adhesive, road tar, silicone, etc. Will not dissolve or mar automotive paint that has been properly aged. Also suitable for use on vinyl or glass surfaces.



**CANNOT BE SHIPPED VIA AIR**  
96-8987-96 (15 oz. Aerosol)

**3M General Purpose Adhesive Cleaner - Liquid**  
A specially blended solvent that provides easy cleanup of most types of adhesives and quickly removes waxes, road tars, grease, oil and similar materials. Will not harm thoroughly dried automotive paint, vinyl or fabrics when properly used.

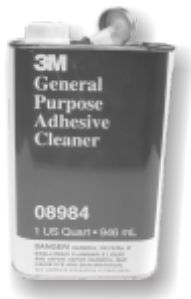

**CANNOT BE SHIPPED VIA AIR**  
96-8984-96 (Quart Can)





**Clip Removal Tool** For removing clips and retainers quickly and easily. Simply seat the tool on the shaft of the fastener and squeeze the handles together. Made of high carbon steel and heat treated for strength. Zinc plated with vinyl molded handle grips. 94-0100-94



**All Purpose Tool** A varied-purpose tool. Assists in the installation of roof, windows, windshield rubber, and back glass. It is used to remove body clips, moldings, springs, cotter pins, and radiator hoses. Great for hard to reach places. 9.5 inches long, 5.5 inch blade. 94-0101-94



**All Purpose Tool** An all-purpose tool with an extra long hook. Use to remove moldings, body clips, windshield seals, cotter pins, and radiator hoses. Made of tough spring steel, heat treated, tempered, and plated. 8 inches long, 4.875 inch blade with 2 inch hook. 94-0102-94



**Tucking Tool** For tucking, headlining, and upholstery around windows, above doors and other hard to reach places. A sturdy, rough tool with a slightly curved blade that has finished edges around corners. Comfortable wood handle. 7.5 inches long, 2.625 inch blade. 94-0104-94



**Glass Retainer Clip Tool** Reduces the risk of chips and scratches to glass windows caused by makeshift tools. This tool is specifically designed to fit trim clips over the studs and virtually eliminates glass breakage. It also dispenses with the need to remove rubber-like sealant surrounding the studs. A practical tool for placing trim retainer clips over headed studs welded around the body window shields and rear window openings. 94-0106-94



**Trim Pad Removing Tool** Designed specifically to pull out the plastic trim pad fasteners used on GM cars. It reaches under the trim panel, supports and grips the plastic fastener, and lifts it without damage to the fastener or to the trim pad backboard. This tool is made of heat treated, high carbon steel and will work equally well on metal fasteners. 8.5 inches long. 94-0107-94



**Trim Pad Removing Tool** For auto trim work. Double ended tool combines both left and right hand. Removes reveal moldings on rubber-less windshield jobs. 9.5 inches long. 94-0108-94



**Door/Trunk Handle - Ferrule Installation Tool** For 1926-1937 G.M. cars and trucks using door & trunk handle ferrules. Without it ferrules are very difficult to install and impossible to reinstall after painting. Installs ferrules by staking them internally. Precision machined, adjustable, plated for durability. 6 inches long. 70-0662-69



**Safety Glasses** Reinforced plastic, clear lenses, and wraparound frame. 94-0109-94



**Plastic Windshield Tool** This handy tool makes replacing windshield gaskets a little easier. A good multi purpose tool too. 8"X11/16" 94-0110-00



**SINCE 1958**

# Our Universal Parts are for Anything!

We built our reputation over decades of producing the highest quality rubber parts and weatherstrip seals for the classic and antique vehicles. Now, we bring our experience and commitment to quality to our line of universal rubber seals. From cars and trucks to boats and recreational vehicles, you can be confident in the great looks, high performance and long life of our universal rubber seals.



## Don't See The Part You Need?

We have thousands of rubber profiles and extrusions in our inventory that may not be listed in this catalog. Give us a call and one of our Product Specialists can assist you in finding the right part for your next project.

**call or email: [parts@steelerubber.com](mailto:parts@steelerubber.com)**

## Parts Availability

New parts are constantly added to our inventory. The availability of new and current parts contained in this catalog is subject to change without notice. Please visit our Online Catalog for updates at [www.steelerubber.com](http://www.steelerubber.com)

## Returns

If you are not completely satisfied with the parts you have purchased from Steele, you may contact us regarding a return and refund. We, however, cannot accept returns of parts that have been installed or altered in any way. We cannot accept returns of less than 12 continuous feet or the original purchase of extruded length if less than 12 feet. Items purchased at bulk rates must be returned in entirety and may be subject to a 25% re-stocking fee. Samples of profiles are available for inspection before purchase by contacting Customer Service department.

## Exchanges

All exchanges of parts will be at our discretion. In some cases, we may exchange a returned part for a similar part that replaces a changed part in our catalog.

## Refunds

We will issue a refund of the purchase price (less discounts and/or restocking fee).

All requests for refund must be accompanied by a copy of the original invoice and the purchased parts. Shipping & Handling Charges may not be refundable.



## Request a Return

Please contact our Customer Service Department at 704-483-9343 to request an exchange or refund. Our representative will provide you with instructions for returning parts to us. We cannot accept refund packages sent C.O.D. or any method for which there is a charge to us. You may return items at swap meets that Steele attends, however you must have a copy of your original receipt and the entire part. Refunds will be sent from our office.

## Return Reseller Parts

Items manufactured and sold by Steele, but purchased through an independent or authorized reseller of Steele parts, must be returned to that same reseller for refund or exchange. Such purchases are subject to the return policies of the reseller.

## Cancellation

Orders that have been processed cannot be cancelled. If you must cancel an order, please call us at 704-483-9343. If an order has been processed, we may charge you for Shipping & Handling. If you refuse delivery of a package, you may be subject to a non-refundable 25% restocking fee.

## Privacy Policy

All customer and sales information provided to us will be maintained by Steele Rubber Products only. We do not sell or share our customer mailing lists. On occasion, Steele will correspond directly with our customers. To change your address, phone number, email address, or other account information, please contact us at 704-483-9343.

## Use Of Parts

These parts are not recommended for specific usage. We are not responsible for damages caused by incorrect installation, abuse, mishandling, accidents or normal wear. Nor will Steele be responsible for labor charges, inconveniences, or any other expenses associated with parts bought through resellers or Steele.

## Copyright

Contents 2015<sup>©</sup> Steele Rubber Products, Inc. Printed in the USA. This catalog may not be reproduced without written permission. All drawings, photographs, and graphic images contained in this catalog are the property of Steele Rubber Products and cannot be reproduced without written permission. The contents of this catalog should not be altered in anyway for commercial or other use.

## Delivery Of Parts

We cannot guarantee a continuous roll of any extrusion in this catalog when ordered in bulk. Therefore, we reserve the right to deliver your parts in multiple lengths to meet your total purchase requirements. We will do our best to ensure that each strip is as long as possible to minimize scrapage for you.

## Method Of Payment

Payment for all orders must be U.S. Funds. Fax orders must be placed with a credit card. Bank guaranteed letters of credit are not accepted. We accept the following . . . VISA, Discover, MasterCard & American Express.

## Same Day Shipping

For fastest delivery, Steele makes every effort to ship orders received by 2:00pm (EST), Monday-Friday on the same day, when parts are in stock. Large orders may require additional manufacturing time.

## Domestic Shipping

For U.S. addresses, we will use our preferred carriers. For details about carriers, please call. Rates are subject to change without notice.

## International Shipping

For Canadian and Overseas orders, customers will be responsible for all shipping, brokerage fees, duties, or other fees. For countries to which parcel post packages cannot be insured by the U.S. Post Office, package safety will be the responsibility of the customer and all losses will be borne by the customer. Rates are subject to change without notice.



# Order Form

Steele Rubber Products  
6180 E. NC 150 HWY  
Denver, NC 28037

Order Toll Free 800-544-8665  
24 Hour Fax 704-483-6650  
Need Help? 704-483-9343

BILLING ADDRESS	
Name	
Address	
City, State, Zip	
Daytime Phone	
SHIPPING ADDRESS	
Name	
Address (No PO Boxes Please)	
City, State, Zip	
Daytime Phone	

E-MAIL ADDRESS

### Vehicle Information

Year
Make
Model
Body Style

Page \_\_\_\_ of \_\_\_\_ Pages

Attach additional Order Forms when the number of items exceeds the spaces on one order form

Page #	Quantity	Part Number	Part Description	Unit Price	Total Price
		-			
		-			
		-			
		-			
		-			
		-			
		-			
		-			
		-			
		-			

NOTE: Parts that are sold "by the foot" please list the number of feet required in the "Quantity" box.



All returns require authorization

METHOD OF PAYMENT	
<input type="checkbox"/> VISA	<input type="checkbox"/> MASTERCARD
<input type="checkbox"/> DISCOVER	<input type="checkbox"/> AMEX
Card No. _____	
Exp. Date _____	CVW # _____
_____ Signature	
<input type="radio"/> Personal Check	<input type="radio"/> Money Order
<input type="radio"/> Cashiers Check	<input type="radio"/> Certified Check
FOR PAYPAL PLEASE CALL 800-230-5871	

SHIPPING FEES		
UNITED STATES (CONTINENTAL)		
Standard	3-6 Days	5.5% of subtotal + \$9.55
Express	2-3 Days	6.5% of subtotal + \$27.75
Express Plus	1 Day	8.5% of subtotal + \$53.35
ALASKA, HAWAII, PUERTO RICO		
Standard	not available	
Express	2-3 Days	8.5% of subtotal + \$55.35
Express Plus	1 Day	17% of subtotal + \$69.40
CANADA *additional brokerage fees will apply		
Standard	6-10 Days	6.5% of subtotal + \$21.30
Express*	3-6 Days	12.5% of subtotal + \$81.20
Express Plus*	2-3 Days	21% of subtotal + \$106.80
OVERSEAS Does NOT include tax or brokerage at border		
Standard	6-10 Days	8.5% of subtotal + \$27.70
Express	2-6 Days	16% of subtotal + \$32.00
Express Plus	call	23% of subtotal + \$170.80

SUBTOTAL
N.C. 7% Sales Tax <i>For North Carolina Residents Only</i>
Shipping & Handling <i>See Chart on the left</i>
<b>TOTAL</b>

### Shipping Notes for Canadian and Overseas Orders

Customers having orders shipped to any location outside of the United States by Parcel Post will be responsible for all costs including, but not limited to, shipping and brokerage fees. In countries to which parcel post packages cannot be insured by the U.S. Post Office, package safety will be the responsibility of the customer and all losses will be borne by the customer. If you live in one of these countries and attend a major Eastern U.S. Antique auto flea market, we suggest you have your prepaid order brought to a flea market attended by us and declare the purchased parts through customs when returning home. You also may have your order shipped to a friend (or business location) in a country that has parcel post insurance. We cannot ship items over 60 inches to most countries. Please contact us for details.





# Order Form

Steele Rubber Products  
6180 E. NC 150 HWY  
Denver, NC 28037

Order Toll Free 800-544-8665  
24 Hour Fax 704-483-6650  
Need Help? 704-483-9343

BILLING ADDRESS	
Name	
Address	
City, State, Zip	
Daytime Phone	
SHIPPING ADDRESS	
Name	
Address (No PO Boxes Please)	
City, State, Zip	
Daytime Phone	

E-MAIL ADDRESS

### Vehicle Information

Year
Make
Model
Body Style

Page \_\_\_\_ of \_\_\_\_ Pages

Attach additional Order Forms when the number of items exceeds the spaces on one order form

Page #	Quantity	Part Number	Part Description	Unit Price	Total Price
		-			
		-			
		-			
		-			
		-			
		-			
		-			
		-			
		-			
		-			

NOTE: Parts that are sold "by the foot" please list the number of feet required in the "Quantity" box.



All returns require authorization

SHIPPING FEES		
UNITED STATES (CONTINENTAL)		
Standard	3-6 Days	5.5% of subtotal + \$9.55
Express	2-3 Days	6.5% of subtotal + \$27.75
Express Plus	1 Day	8.5% of subtotal + \$53.35
ALASKA, HAWAII, PUERTO RICO		
Standard	not available	
Express	2-3 Days	8.5% of subtotal + \$55.35
Express Plus	1 Day	17% of subtotal + \$69.40
CANADA *additional brokerage fees will apply		
Standard	6-10 Days	6.5% of subtotal + \$21.30
Express*	3-6 Days	12.5% of subtotal + \$81.20
Express Plus*	2-3 Days	21% of subtotal + \$106.80
OVERSEAS Does NOT include tax or brokerage at border		
Standard	6-10 Days	8.5% of subtotal + \$27.70
Express	2-6 Days	16% of subtotal + \$32.00
Express Plus	call	23% of subtotal + \$170.80

<b>SUBTOTAL</b>
N.C. 7% Sales Tax <i>For North Carolina Residents Only</i>
Shipping & Handling <i>See Chart on the left</i>
<b>TOTAL</b>

METHOD OF PAYMENT	
<input type="checkbox"/> VISA	<input type="checkbox"/> MASTERCARD
<input type="checkbox"/> DISCOVER	<input type="checkbox"/> AMEX
Card No. _____	
Exp. Date _____	CVW # _____
_____ Signature	
<input type="checkbox"/> Personal Check	<input type="checkbox"/> Money Order
<input type="checkbox"/> Cashiers Check	<input type="checkbox"/> Certified Check
FOR PAYPAL PLEASE CALL 800-230-5871	

### Shipping Notes for Canadian and Overseas Orders

Customers having orders shipped to any location outside of the United States by Parcel Post will be responsible for all costs including, but not limited to, shipping and brokerage fees. In countries to which parcel post packages cannot be insured by the U.S. Post Office, package safety will be the responsibility of the customer and all losses will be borne by the customer. If you live in one of these countries and attend a major Eastern U.S. Antique auto flea market, we suggest you have your prepaid order brought to a flea market attended by us and declare the purchased parts through customs when returning home. You also may have your order shipped to a friend (or business location) in a country that has parcel post insurance. We cannot ship items over 60 inches to most countries. Please contact us for details.



SINCE 1958

*Steele Rubber Products  
6180 E. NC 150 HWY  
Denver, NC USA 28037  
Toll Free 800-230-5871*